

GB Instruction for use

POWERTEX Chain Block PCB-S2

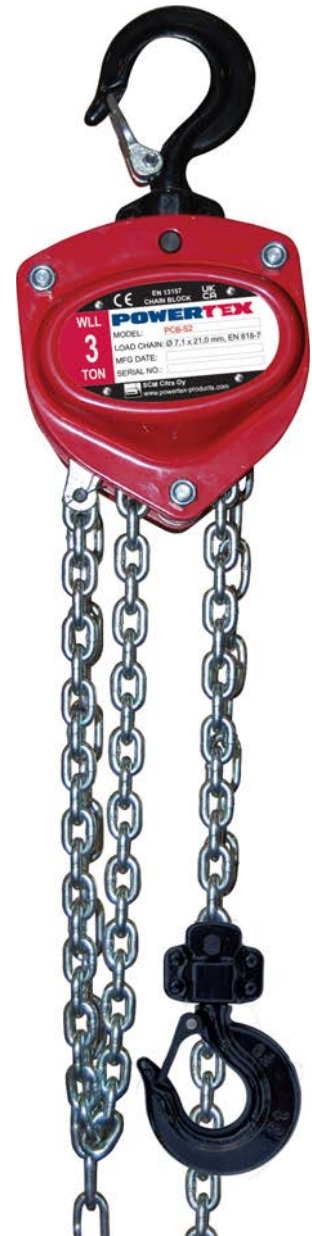

User Manual



POWERTEX Chain Block PCB-S2 0,25 – 10 ton Instruction for use (GB) (Original instructions)

Read through these user instructions carefully before using the chain block. Improper operation may lead to hazardous situations!

General safety provisions

- Only to be used by trained operator.
- Do not use in explosive or corrosive environment.
- Temperature range: -10°C up to +50°C.
- Check the function of the chain block before use. See "Daily checks" on page 3.
- Full function of the brake system can only be secured at a minimum load of 30 kg for capacities (WLL) up to 1 ton, and for capacities (WLL) above 1 ton, the minimum load to be greater than 3% of the rated capacity (WLL).
- Do not exceed the maximum load.
- Handle the chain block with care. Do not throw the block about or let it fall to the ground.
- Do not use the chain block for welding work where it is exposed to welding spatter or current.
- The chain block must not be used for lifting persons.

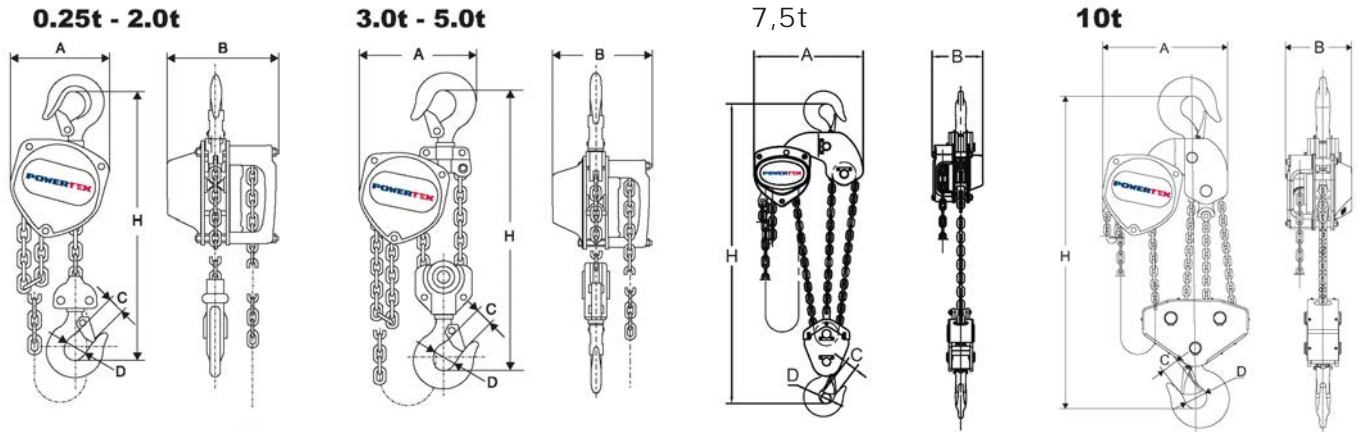

Data

Model	WLL (ton)	Hand force max. (kg)	Load chain (mm)	Number of falls	Hand chain (mm)	Weight* (kg)
PCB-S2/250KG	0,25	23,5	4,0 x 12,0	1	5,0 x 23,7	5,9
PCB-S2/500KG	0,5	24,9	5,0 x 15,0	1	5,0 x 23,7	9,8
PCB-S2/1000KG	1	28,4	6,3 x 19,0	1	5,0 x 23,7	11,7
PCB-S2/2000KG	2	34,3	8,0 x 24,0	1	5,0 x 23,7	18,9
PCB-S2/3000KG	3	34,3	7,1 x 21,0	2	5,0 x 23,7	28,9
PCB-S2/5000KG	5	37,2	9,0 x 27,0	2	5,0 x 23,7	37,1
PCB-S2OLP/500KG	0,5	24,9	5,0 x 15,0	1	5,0 x 23,7	9,8
PCB-S2OLP/1000KG	1	28,4	6,3 x 19,0	1	5,0 x 23,7	11,7
PCB-S2OLP/2000KG	2	34,3	8,0 x 24,0	1	5,0 x 23,7	18,9
PCB-S2OLP/3000KG	3	34,3	7,1 x 21,0	2	5,0 x 23,7	28,9
PCB-S2OLP/5000KG	5	37,2	9,0 x 27,0	2	5,0 x 23,7	37,1
PCB-S2OLP/7500KG	7,5	36,8	9,0 x 27,0	3	5,0 x 23,7	50,0
PCB-S2OLP/10000KG	10	40,0	9,0 x 27,0	4	5,0 x 23,7	92,8
PCB-S2BK/500KG	0,5	24,9	5,0 x 15,0	1	5,0 x 23,7	9,8
PCB-S2BK/1000KG	1	28,4	6,3 x 19,0	1	5,0 x 23,7	11,7

* With standard 3m lifting height. OLP = Overload Protection. BK = Blackline.

Dimensions

WLL ton	A mm	B mm	C mm	D mm	H min. mm
0,25	108	106	20	30	260
0,5	130	128	22	34	280
1	150	145	26	39	330
2	185	175	35	49	385
3	220	158	37	50	510
5	255	183	43	60	615
7,5	430	189	47	67	690
10	360	183	47	65	820

Safety factor: 4:1.

Dynamic test coefficient: WLL x 1,5.

Generally according to EN 13157.

Function

The load hook is raised or lowered by pulling on the hand chain.
 The load will remain where it is when the hand chain is released because of the effective reaction brake.
 Max. hand force need to be respected to avoid overloading of the hoist.

The Over Load Protection (OLP) versions are additionally equipped with an overload protection device that will limit the force that can be applied using the hand chain.

If the OLP device is activated the hand chain will rotate but the hoist will not continue to lift, only lowering is possible.
 The overload protection device is adjusted in the factory to approx. 1,3 x WLL and the device normally don't need to be adjusted.

Suspension of chain block

Suspend the block from an eye, shackle, girder trolley etc. with sufficient load capacity. With the chain tightened, both hooks must be vertically aligned.



NB! No bending stresses may be applied to block, hooks or load chain.

Raising/lowering

Only use straps and slings of sufficient load capacity. Check that the load is not anchored to the floor/ground or is otherwise fixed before making the lift. Ensure that the load chain hangs vertically and has no kinks. The hand chain must also be in good condition and easily accessible. The load is raised or lowered by pulling the hand chain in either direction.

Warning: Do not overload the brake by prolonged lowering. It may cause brake function to fail.

Warning:

- Only hand power from a single person is permitted on the hand chain. If the chain feels too heavy, use a bigger chain block or reduce the load.
- Make sure no-one stands beneath a hanging load.
- Do not step onto a hanging load.
- Do not raise or lower so far that the load hook hits the block housing.
- The chain block must not be used for pulling loads.
- The block must not be subjected to dynamic stresses, for example where a load connected to the block is launched from a height.
- Do not leave a block with a suspended load unattended.

Attachment of loads

Check the equipment before use. Improper attachment of loads can be highly dangerous (see Figs. 2 a – 2 e).

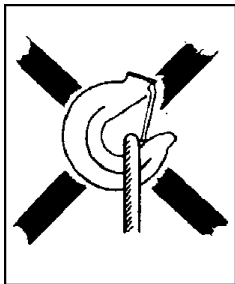

Fig 2 a
 The sling is applying load to the hook tip

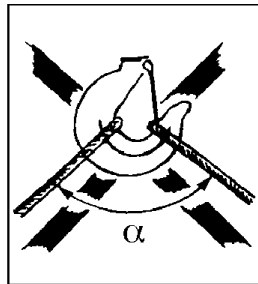

Fig 2 b
 Excessive top angle on sling!
 α max. 60°

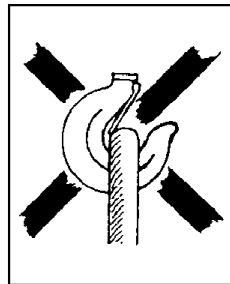

Fig 2 c
 Hook latch obstructed

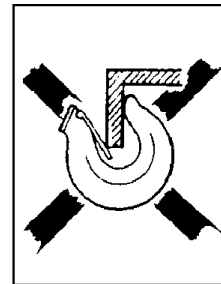

Fig 2 d
 Hook tip subject to additional bending stress

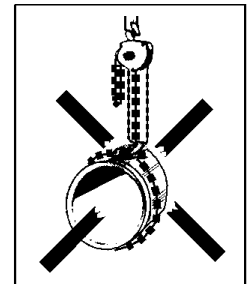

Fig 2 e
 Load chain must not be used as a sling

Multiple lifting

Multiple lifting entails special risks. This is when two or perhaps more hoists are used simultaneously for the same load. Danger to persons and material damage can arise due to dynamic stresses and uneven load distribution causing individual hoists to become overloaded. A competent person with experience in multiple lifting must therefore supervise this type of lifting tasks.

The total weight of the target object and its load distribution must be known or calculated.

For a variety of reasons, the centre of gravity can be difficult to determine, and thus so will the distribution of the load each chain hoist must bear. In cases where heavy, bulky loads must be handled and it is not possible to estimate all factors correctly, the working load limit (WLL) of each chain hoist must be reduced by at least 25%.

Daily checks

After every working day on which the chain block has been used, the following should be checked:

- Is the chain block deformed or otherwise damaged? Are any parts missing?
- Is any deformation or other damage visible on the suspension device (eye, shackle, bolt, trolley etc.)?
- Are the hooks intact or have any hooks opened? Are the hook latches correct and functional?
- Wipe down the chain block and oil the load chain as required.
- The load chain must be undamaged, i.e. no signs of wear and no deformed or otherwise damaged links.
- The load chain must not be kinked or twisted. With two-fall or multi-fall chain blocks there is a risk of the chain twisting if the bottom hook assembly ends up looped through the chain sling – usually during refitting or moving the chain block between work stations. See Fig 3.
- The hand chain must also be in good condition.
- The brake function must be intact.

In the event of faults or failures, the block must be repaired and carefully checked by a specialist before reuse.

Continuous maintenance - lubrication

Oil the hook latches and bearings. Grease the pawl and ratchet and also the gear. Lubrication must be sparingly and carefully applied so no grease gets on the brake disk. Oil the load chain for longer life.

Periodic checks

Periodic checks are normally carried out yearly to detect and remedy any faults. If required (e.g. high frequency of use), more frequent checks may be carried out. See "Checklist for periodic checks". Measure hooks and chain to detect any changes in shape.

Checks on load hook (see Fig. 4 and Table 1)

Opening dimension C on the hooks is important. A hook with too large a maximum dimension has been exposed to overloading or overheating. It therefore does not have the necessary load capacity. The hooks may also have been exposed to long-term wear (dimension K).

Hooks must be discarded and replaced if:

- The maximum C value is exceeded (according to Table 1)
- The minimum K value falls short (according to Table 1)
- The hook shows signs of cracking
- The hook is deformed or otherwise damaged

Defective hooks must be replaced before using the chain block again.

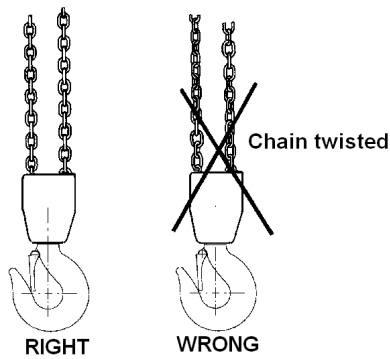

Fig. 3 The chain must not be twisted

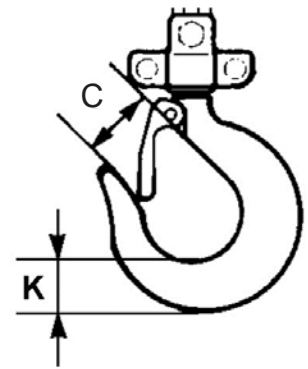

Fig. 4 Load hook

Table 1 Load hook

WLL t	0,25	0,5	1	2	3	5	7,5	10
Model	PCB-S2	PCB-S2	PCB-S2	PCB-S2	PCB-S2	PCB-S2	PCB-S2	PCB-S2
Dimension C nominal mm	24	25,5	30	38,5	41,5	47	57	55
Dimension C max mm	26,4	28,0	33	42,3	45,5	51,7	62,7	60,5
Dimension K nominal mm	15	19	25	33,5	39	44,5	65,5	62
Dimension K min mm	13,5	17,1	22,5	30,2	35,1	40,0	59	55,8

Checks on load chain (see Fig. 5 and Table 2)

Inspect the load chain over its whole length to detect any deformed or otherwise damaged links. Make a check measurement of suspect links. Measure the worn areas Also, every 300 mm (normally), make check measurements of the internal length of 5 links (pitch dimension 5xP – according to Table 2).

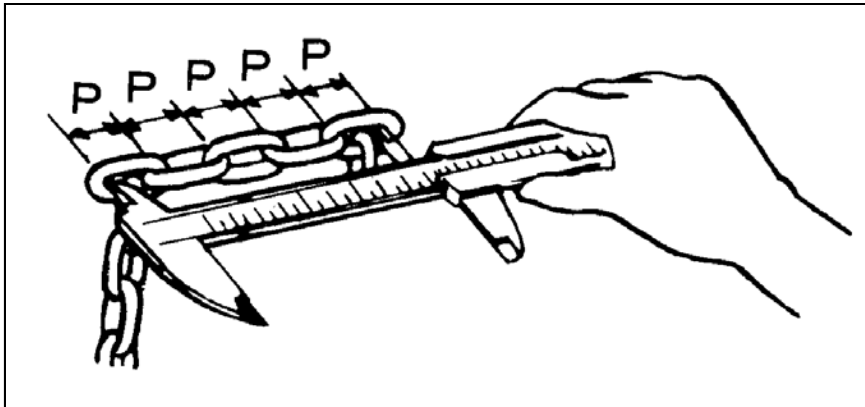

Fig 5 Checking load chain dimensions

Table 2 Load chain

Max. load t	0,25	0,5	1	2	3	5	7,5	10
Model	PCB-S2	PCB-S2	PCB-S2	PCB-S2	PCB-S2	PCB-S2	PCB-S2	PCB-S2
Link diameter nominal mm	4,0	5,0	6,3	8,0	7,1	9,0	9,0	9,0
Link diameter min. mm	3,6	4,5	5,7	7,2	6,4	8,1	8,1	8,1
Pitch dimension (5xP) nominal mm	60,0	75,0	95,0	120,0	105,0	135,0	135,0	135,0
Pitch dimension (5xP) max. mm	61,8	77,2	98,0	123,5	108,1	139,0	139,0	139,0

The load chain must be discarded and replaced if:

- cracks are detected on any link
- any link is deformed or otherwise damaged
- The minimum value of any link's diameter falls short
- the maximum value of the pitch dimension is exceeded at any point
- the chain is damaged by overheating or has been affected by weld splatter

Load chains must **not** be repaired – they must be replaced by new chain. If it is desired to lengthen the chain, it must be replaced by a new and longer chain.

Replacement of the chain shall be performed professionally by an authorized repairer and the chain must meet the requirements stated in the standard EN 818-7, Grade T from the following manufacturers: Chaineries Limousines, Pewag, Thiele or Rud.

Repairs

The chain block must not be modified. Repairs must be carried out by specialists. Damaged parts must only be replaced with original Powertex Parts. Order them through your dealer.

EC Declaration of conformity

SCM Citra OY

Asessorinkatu 3-7

20780 Kaarina, Finland

www.powertex-products.com

hereby declares that the POWERTEX product as described above is in compliance with EC Machinery Directive 2006/42/EC & EN 13157.

UK Declaration of conformity

SCM Citra OY

Asessorinkatu 3-7

20780 Kaarina, Finland

www.powertex-products.com

hereby declares that the POWERTEX product as described above is in compliance with the Supply of Machinery (Safety) Regulations 2008 & BS EN 13157.

Checklist for periodic checks (normally yearly – more frequently if necessary)

Daily	Yearly	Inspection items	Inspection method	Note
Labels				
X	X	Rating plate	Visual	If the plate is hard to read - replace it
Function				
X	X	Raising and lowering function	Test without load	A low snapping noise should be audible
-	X	Raising and lowering function	Test with rated weight for min 300 mm	Load chain sprocket and chain work well together. Brake works. Hand pulling on the hand chain feels even and not too heavy
Hooks				
X	-	Hook opening	Visual Measurements	Looks normal See Fig. 4 and Table 1
-	X			
X	X	Deformation	Visual	No visible deformation
X	X	Hook bearing	Visual	No abnormal play
X	-	Wear, cracks, deformation and corrosion	Visual Measurements	No visible damage See Fig. 4 and Table 1
-	X			
X	X	Hook latches	Visual	Works, spring undamaged
Load chain				
X	-	Pitch	Visual Measurement	Looks normal. Measure in case of doubt See Fig. 5 and Table 2
-	X			
X	-	Wear	Visual Measurement	Looks problem-free. Measure in case of doubt See Fig. 5 and Table 2
-	X			
X	X	Deformation	Visual	No deformation. Measure in case of doubt
X	X	Cracks etc.	Visual	No cracks
X	X	Rust	Visual	No rust
Housing				
X	X	Frame	Visual	No deformation and no rust
X	X	Gearbox	Visual	No deformation
-	X	Gears	Visual after dismantling	No serious wear or fractures
-	X	Load chain sprocket	Visual after dismantling	No serious wear or cracks. No fractures or deformation
-	X	Hand chain sprocket	Visual	No serious wear or cracks. No fractures or deformation
-	X	Bearings	Visual, testing	No damage, smooth running
Screws				
X	X	Screws, nuts, rivets, cotters etc.	Visual	Must not be missing. Tighten loose items. Replace as necessary
Brake				
-	X	Brake disk	Visual	Replace if worn
-	X	Brake screw	Visual	No serious wear
-	X	Pawl and ratchet	Visual	Replace worn parts. Carefully lubricate with grease

POWERTEX Chain Block PCB-S2 – Parts 0,25 t

When ordering parts, specify model, WLL, pos number, description and the quantity needed.

When ordering chain, also specify lifting height.

If the load chain has been damaged or worn out the load sheave probably has to be replaced.

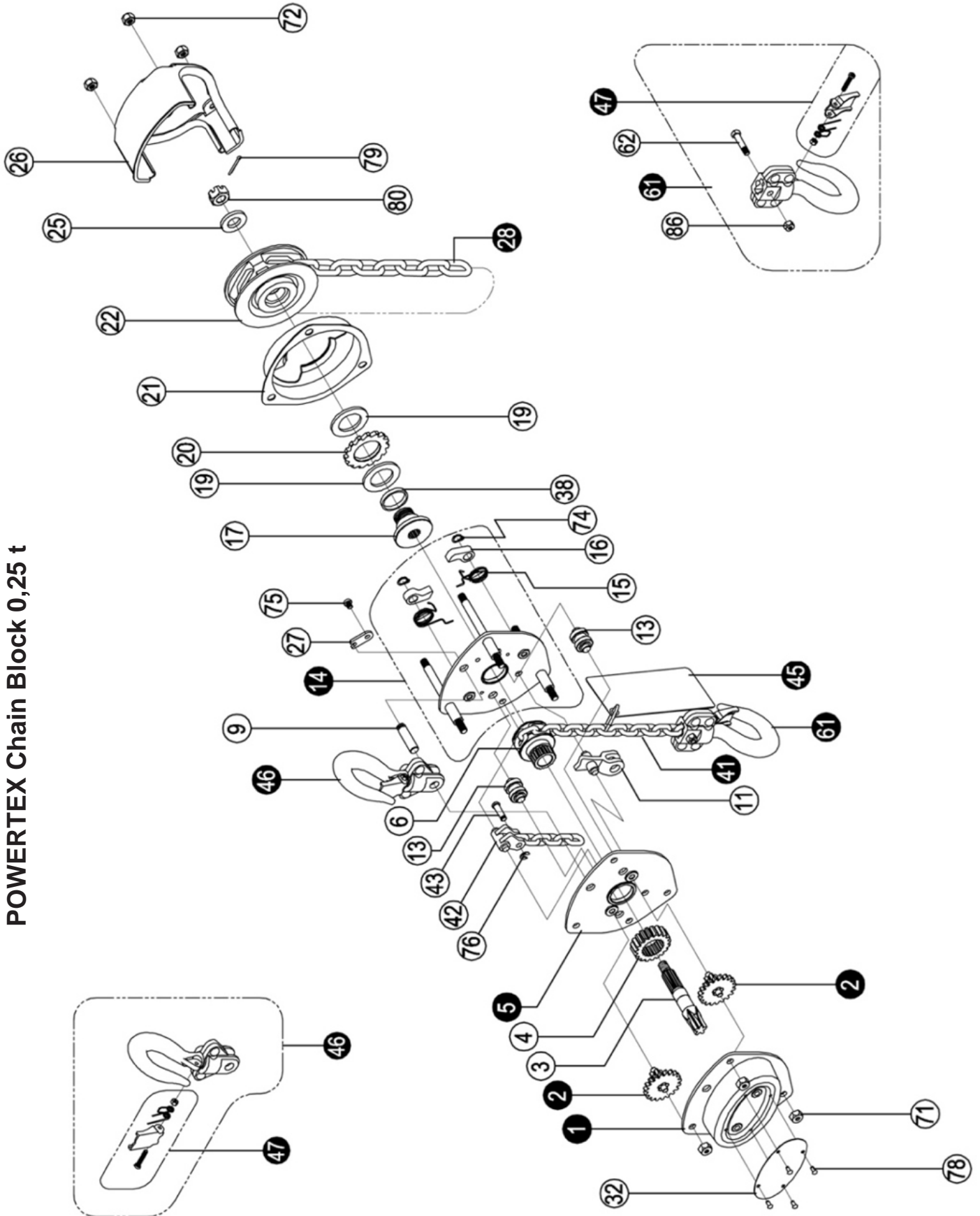

POWERTEX Chain Block 0,25 t

Parts list 0,25 t

Pos	Description
1	Gear cover assy
2	Disc gear assy
3	Drive shaft
4	Splined gear
5	Right side plate assy
6	Load chain sprocket
9	Top hook shaft
11	Chain stripper
13	Guide roller
14	Left side plate assy
15	Pawl spring
16	Pawl
17	Brake seat
19	Friction plate
20	Ratchet wheel
21	Brake cover
22	Hand chain wheel
25	Washer
26	Hand chain cover
27	Positioned plate
28	Hand Chain
32	Name plate
41	Load Chain
42	End anchor
43	End anchor pin
45	Warning plate assy
46	Top hook assy
47	Safety latch assy
61	Bottom hook assy
62	Bottom hook pin
71	Metal lock nut
72	Metal lock nut
74	Circlip
75	Cross head screw
76	Split retainer
78	Name plate
79	Split pin
80	Hexagon nut

POWERTEX Chain Block PCB-S2 – Parts 0,5 – 5 t

When ordering parts, specify model, WLL, pos number, description and the quantity needed.

When ordering chain, also specify lifting height.

If the load chain has been damaged or worn out the load sheave probably has to be replaced

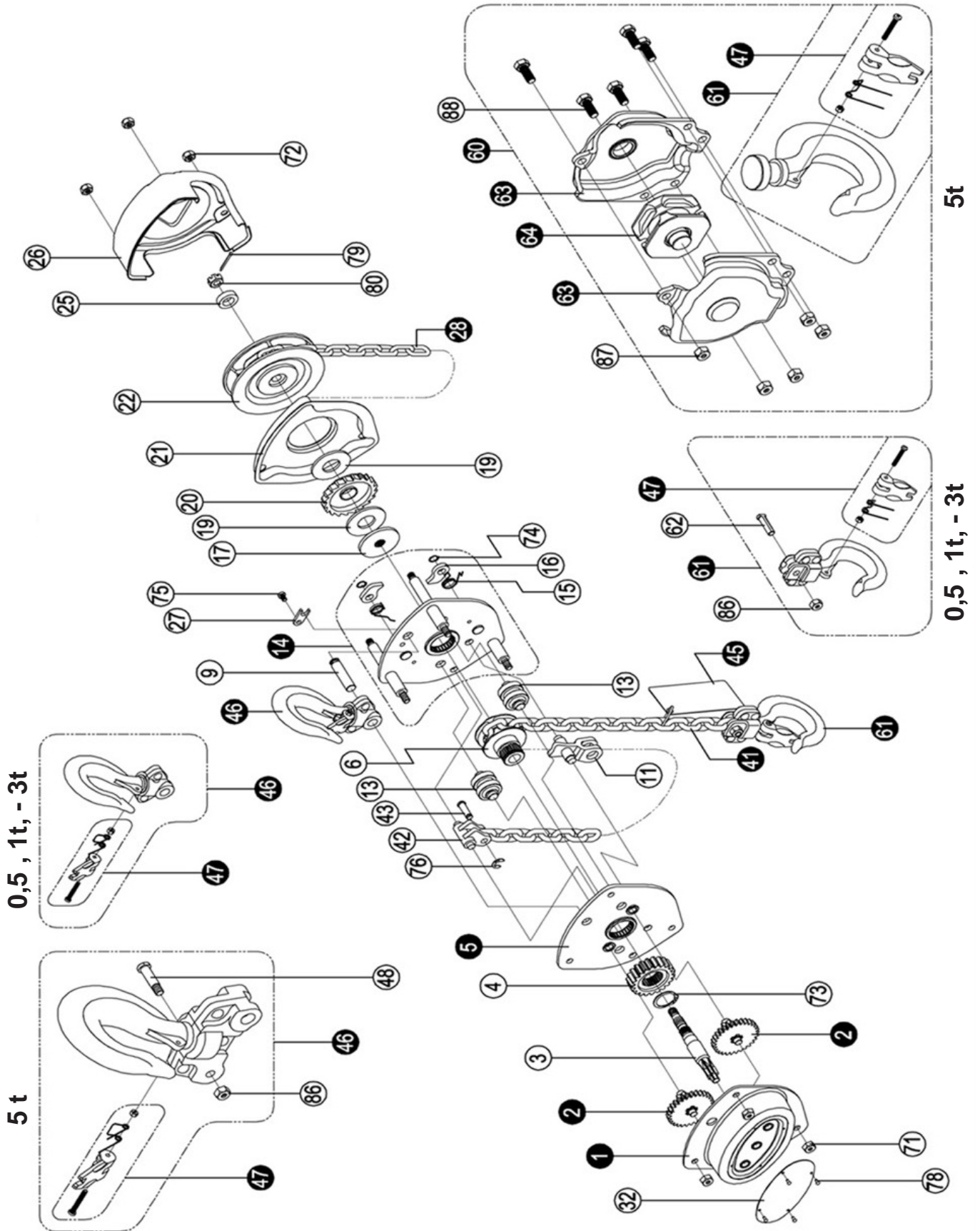

Parts list 0,5 – 5 t

Pos	Description
1	Gear cover assy
2	Disc gear assy
3	Drive shaft
4	Splined gear
5	Right side plate assy
6	Load chain sprocket
9	Top hook shaft
11	Chain stripper
13	Guide roller
14	Left side plate assy
15	Pawl spring
16	Pawl
17	Brake seat
19	Friction plate
20	Ratchet wheel
21	Brake cover
22	Hand chain wheel
25	Washer
26	Hand chain cover
27	Positioned plate
28	Hand Chain
32	Name plate
41	Load Chain
42	End anchor
43	End anchor pin
45	Warning plate assy
46	Top hook assy
47	Safety latch assy
48	Top hook pin
60	Bottom hook assy
61	Bottom hook assy
62	Bottom hook pin
63	Bottom hook connector assy
64	Idler sheave assy
71	Metal lock nut
72	Metal lock nut
73	Circlip
74	Circlip
75	Cross head screw
76	Split retainer
78	Name plate
79	Split pin
80	Hexagon nut
86	Metal lock nut
87	Metal lock nut
88	Bolt M10x25

POWERTEX Chain Block PCB-S2 – Parts 7,5 t hooks. Parts for hoist body same as for 10 t

When ordering parts, specify model, WLL, pos number, description and the quantity needed.

When ordering chain, also specify lifting height.

If the load chain has been damaged or worn out the load sheave probably has to be replaced.

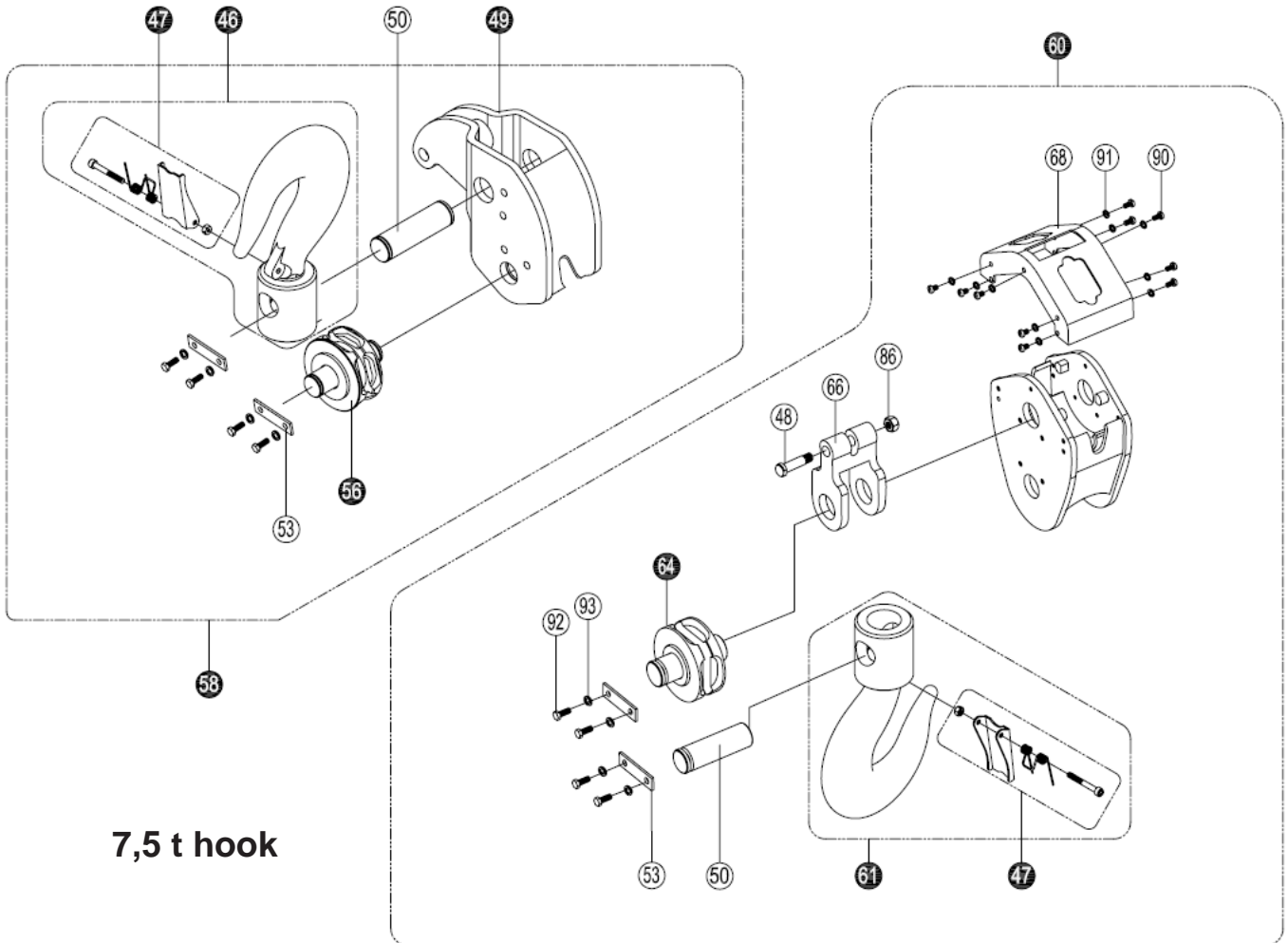

7,5 t hook

Parts list hooks 7,5 t hook

Pos	Description
46	Top hook assy
47	Safety latch assy
48	Top hook pin
49	Top Hook connector
50	Shaft
53	Positioning plate
56	Top hook Idler sheave assy
58	Top Hook complete set
60	Bottom hook complete set
61	Bottom hook assy
64	Bottom hook Idler sheave assy
66	Chain holder
68	Protection cover
86	Metal lock nut M10
90	Screw
91	Spring washer
93	Spring washer
92	Bolt

**POWERTEX Chain Block PCB-S2 – Parts 7,5 t and 10 t
(below hooks are for 10 t. See previous page for 7,5 t hooks)**

When ordering parts, specify model, WLL, pos number, description and the quantity needed.

When ordering chain, also specify lifting height.

If the load chain has been damaged or worn out the load sheave probably has to be replaced.

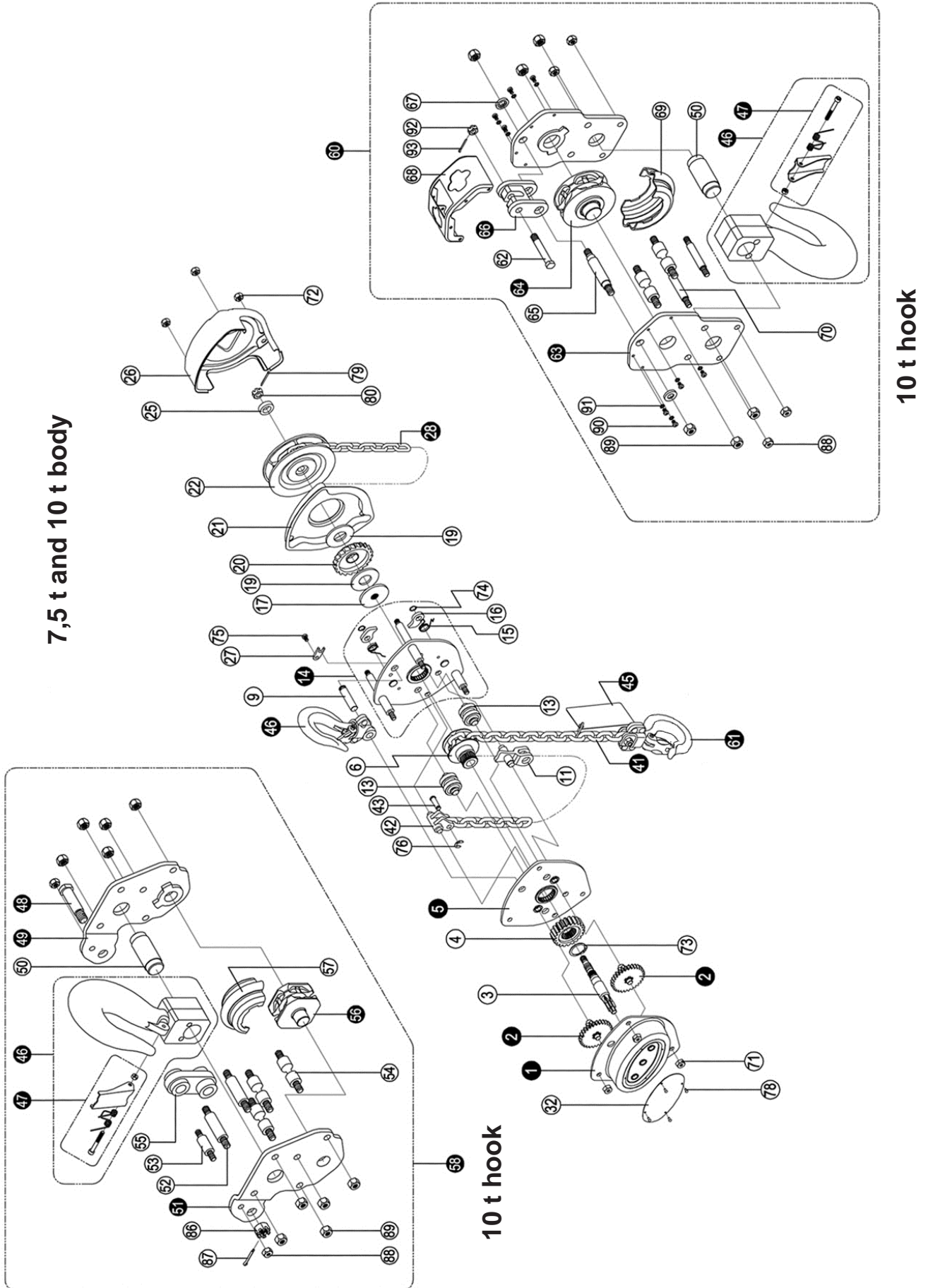

Parts list 10 t

Pos	Description	Pos	Description
1	Gear cover assy	54	Stay bolt B
2	Disc gear assy	55	Suspension plate
3	Drive shaft	56	Idler sheave assy
4	Splined gear	57	Protection cover
5	Right side plate assy	58	Top hook assy
6	Load chain sprocket	60	Bottom hook assy
9	Top hook shaft	62	Bottom hook pin
11	Chain stripper	63	Hook plate
13	Guide roller	64	Bottom idler sheave assy
14	Left side plate assy	65	Shaft
15	Pawl spring	66	Plate
16	Pawl	67	Washer
17	Brake seat	68	Protection cover
19	Friction plate	69	Cover
20	Ratchet wheel	70	Bolt
21	Brake cover	71	Metal lock nut
22	Hand chain wheel	72	Metal lock nut
25	Washer	73	Circlip
26	Hand chain cover	74	Circlip
27	Positioned plate	75	Cross head screw
28	Hand chain	76	Split retainer
32	Name plate	78	Name plate
41	Load chain	79	Split pin
42	End anchor	80	Hexagon nut
43	End anchor pin	86	Hexagon recess nut
45	Warning plate assy	87	Split pin
46	Top hook assy	88	Metal lock nut
47	Safety latch assy	89	Metal lock nut
48	Top hook pin	90	Cross head screw
49	Plate (right)	91	Light spring washer
50	Shaft	92	Hexagon recess nut
51	Plate (left)	93	Split pin
52	Stay bolt A		
53	Short bolt		

CertMax+

The CertMax+ system is a unique leading edge certification management system which is ideal for managing a single asset or large equipment portfolio across multiple sites. Designed by the Lifting Solutions Group, to deliver optimum asset integrity, quality assurance and traceability, the system also improves safety and risk management levels.



Marking

The POWERTEX Chain Block is equipped with a RFID (Radio-Frequency Identification) tag, which is a small electronic device, that consist of a small chip and an antenna. It provides a unique identifier for the block.



The POWERTEX Chain Block is **CE** and **UKCA** marked.

Standard: EN 13157



Warning tag

The warning tag shows some specific and important situations, in which you must pay special attention, when using POWERTEX Chain Blocks and Lever Hoists.



User Manuals

You can always find the valid and updated User Manuals on the web. The manual is updated continuously and valid only in the latest version.

NB! The English version is the Original instruction.

The manual is available as a download under the following link:
www.powertex-products.com/manuals



Product compliance and conformity



SCM Citra OY
 Asessorinkatu 3-7
 20780 Kaarina
 Finland
www.powertex-products.com

POWERTEX

www.powertex-products.com